

CITY CRANE E12-12A

2A.7.005.12 1/4

POTAIN

Mats - Maste - Masts - Mástil - Torre



□ 1,2m

Flèche - Ausleger - Jib
Flecha - Braccio
30m = 43m

PA 270

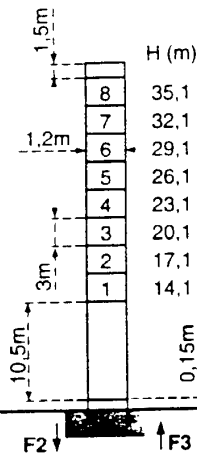

F2	● 63t	■ 72t
F3	● 44t	■ 55t

⊕	22t
---	-----

PA 265

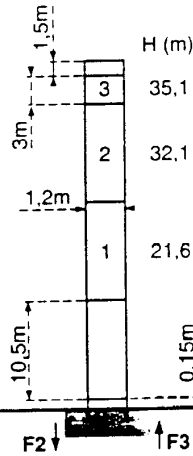

F2	● 63t	■ 72t
F3	● 44t	■ 55t

⊕	22t
---	-----

BA 25A

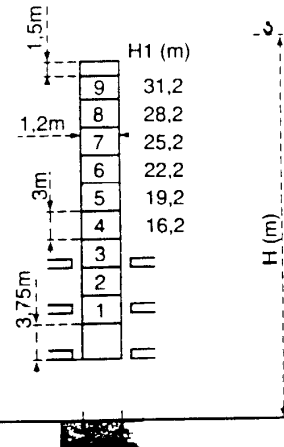

Voir ci-contre
Siehe nebenstehend
See opposite
Ver pagina opuesta
Vedi pagina accanto

ZF 265

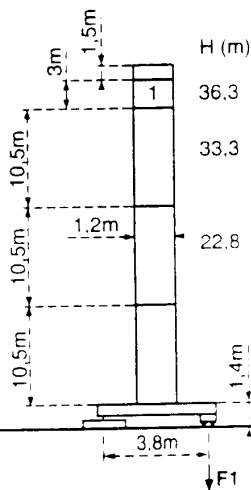

F1	● 38t	■ 43t
----	-------	-------

⊕	27t
---	-----

ZF 270

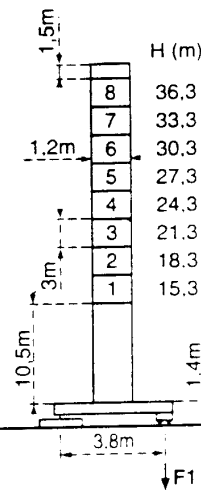

F1	● 38t	■ 43t
----	-------	-------

⊕	27t
---	-----

F = Réactions - Eckdrücke - Reactions - Reacciones - Reazioni

Courbes de charges - Lastkurven - Load diagrams - Curvas de cargas - Curve di carico

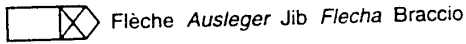

43 m	23,6	25	27	30	32	35	37	40	43	m
	2,5	2,34	2,13	1,88	1,74	1,60	1,45	1,31	1,2	

40 m	24,7	25	27	30	32	35	37	40	m
	2,5	2,47	2,26	1,99	1,84	1,65	1,54	1,4	

35 m	25,9	27	30	32	35	m
	2,5	2,38	2,1	1,95	1,75	

30 m	26,9	27	30	m
	2,5	2,49	2,2	

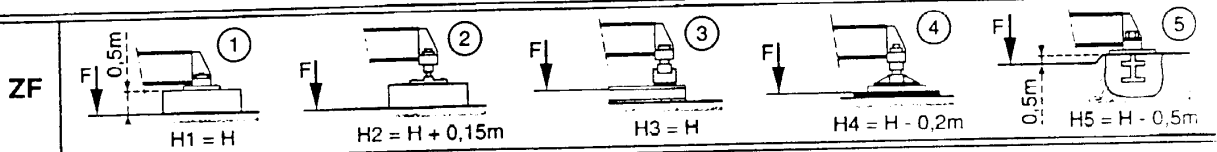

**Télescopage sur dalles - Kletterkrane im Gebäude - Climbing crane
Telescopage gruas trepadoras - Gru in cavedio**

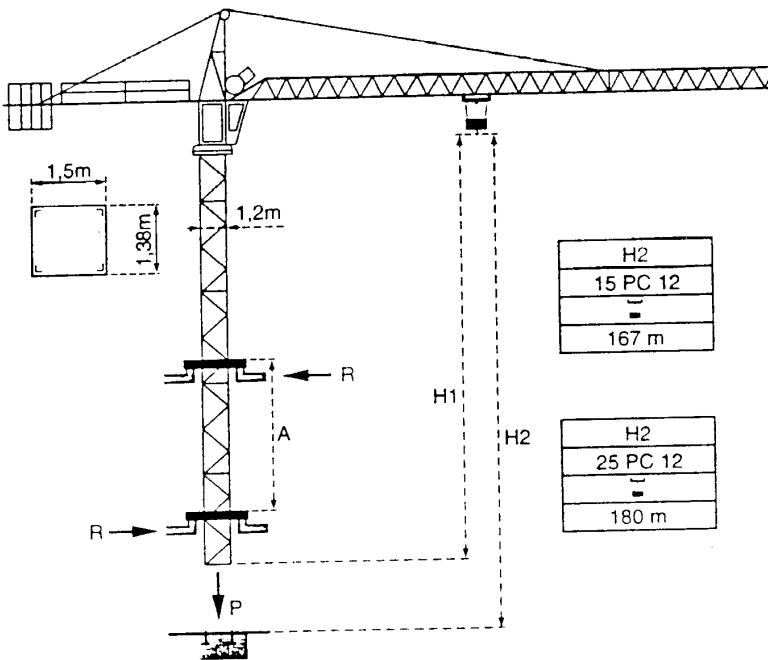

BA 25A

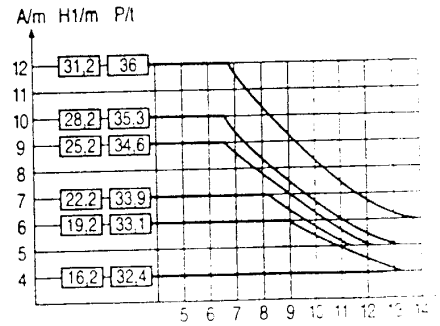























- | | | | | |
|---------------------------------|-------------------------------|-----------------------------|---------------------------------|--------------------------------|
| A Distance entre cadres | A Abstand zwischen den Rahmen | A Distance between collars | A Distancia entre marcos | A Distanza tra i telai |
| H1 Hauteur grue | H1 Kranhöhe | H1 Crane height | H1 Altura grua | H1 Altezza gru |
| P Poids de la grue (en service) | P Krangewicht (in Betrieb) | P Crane weight (in service) | P Peso de la grua (en servicio) | P Peso de la gru (in servizio) |
| R Réaction horizontale | R Horizontalkräfte | R Horizontal reaction | R Reaccion horizontal | R Reazione orizzontale |

- | | | | | |
|--|--|---|--|--|
| ● En service | ● In Betrieb | ● In service | ● En servicio | ● In servizio |
| ■ Hors service | ■ Ausser Betrieb | ■ Out of service | ■ Fuera de servicio | ■ Fuori servizio |
| ⊗ A vide sans lest avec fleche et hauteur maximum. | ⊗ Ohne Last und Ballast mit Maximalausleger und Maximalhöhe. | ⊗ Without load and ballast with longest jib and maximum height. | ⊗ Sin carga, sin lastre con flecha y altura máximas. | ⊗ A vuoto senza zavorre e con braccio massimo e altezza massima. |

LA.7.005.12 3/4

POTAIN CITY CRANE E12-1.

Mécanismes - Antriebe - Mechanisms - Mecanismos - Meccanismi

				m/min	t		ch -PS hp	kW
Levage Heben Hoisting Elevación Sollevamento	15 PC 12   			7	2,5	335 m	15	11
				21	2,5			
				42	1,25			
	25 PC 12   			6	2,5	360 m	25	18,4
				35	2,5			
				70	1,25			
Distribution - Katzfahren - Trolleying Distribución - Distributions		3 D1 V5		36			3	2,2
		3 D2 V5 - 1		21 - 42			3	2,2
Orientation - Schwenken - Slewing Orientación - Rotazione		RCV 40		0 → 0,8 tr/min U/min-rpm			6	4,5
Translation - Kranfahren - Travelling Traslación - Traslazione	ZF  	TVD 324 C1		26			2 x 4	2 x 2,9
Réseau - Netzstrom - Mains supply - Red - Rete elettrica							380V - 50Hz	
Puissance électrique nécessaire - Anschlusswert - Necessary electric power Potencia eléctrica necesaria - Potenza elettrica necessaria							15 PC : 25 KVA 25 PC : 35 KVA	
Groupe électrogène - Stromaggregat - Generator set - Grupo electrogeno - Gruppo elettrogeno							•	

*Nous consulter - Auf Anfrage - Consult us - Consultarnos - Consultateci

Conforme à la directive CEE 84/534 sur le niveau acoustique - Gemäss EWG-Richtlinie 84/534 Schall- Leistungspegel
 In compliance with the EEC 84/534 Instruction on noise level - Conforme con la directiva CEE 84/534 sobre el nivel acustico
 Conforme colla direttiva CEE 84/534 sul livello acustico

NF E 52081 - 82

Copyright.Reproduction interdite © POTAIN 1992

POTAIN 

GROUP LEGRIS INDUSTRIES

18, Rue de Charbonnières, B.P. 173-F 69132 ECULLY Cedex
 Tel. 72 20 20 20 - Télex 375 213 - Fax 72 20 20 00

Modifiche riservate - Modificaciones reservadas - Subject to modification - Änderungen vorbehalten - Änderungen vorbehalten